

6UEC35LSE

諸管線図集















PIPING DIAGRAM

Engine Type	Turbocharger Type	X : Apply	
		Tier2	Tier3
6UEC35LSE-B2 6UEC35LSE-C1	MET 42MB/-EGB×1	x	
	MET 37MB/-EGB×1	x	
	MET 33MB/-EGB×1	x	

CONTENT		REMARKS	PURCHASER	ORDER No.	DATE	Japan Engine Corporation Development & Design Department		
DESCRIPTION	14 PAGE			ITEM No.	REFERENCE	APPROVED BY	M.Sugihara N.Kunihiro	
FIGURE	5 SHEET					CHECKED BY	K.Edo S.Yoshikawa	
TOTAL	21 PAGE					DESIGNED BY	K.Imanaka	
						DRAWN BY		
						ISSUE		
						DATE	2011.11.8	
FACTORY						DWG. No.	U7-0E051	
						Rev. No.	D	











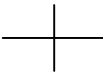
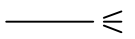
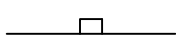

諸管線図名称

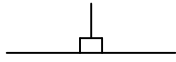
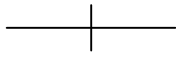
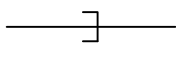
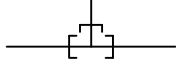

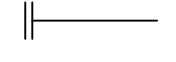
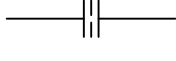



Name of piping diagram



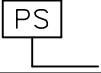
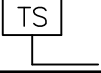

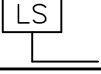
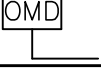
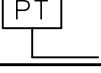
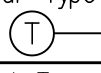
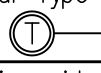
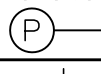
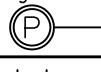
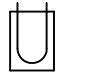
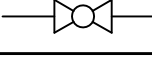

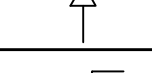

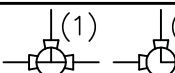
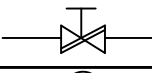
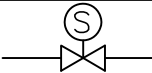
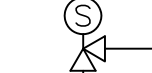



U7-0E051		Starting air 始動空気管線図
" "		Fuel oil 燃料油管線図
" "		Fuel oil steam 燃料油加熱蒸気管線図
" "		Lubricating oil 潤滑油管線図
" "		Piston cooling oil ピストン冷却油管線図
" "		Actuator oil for exhaust valve 排気弁駆動油管線図
" "		Cylinder lubricating oil シリンダ注油管線図
" "		Turbocharger lubricating oil 過給機潤滑油管線図
" "		Cylinder cooling water シリンダ冷却水管線図
" "		Air cooler cooling water 空気冷却器冷却水管線図
" "		Piston rod stuffing box drain ピストン棒パッキン箱ドレン管線図
" "		Scavenging air trunk drain 掃気トランクドレン管線図
" "		Turbocharger and air cooler washing 過給機, 空気冷却器洗浄水管線図
" "		Fire extinguishing 掃気室火災消火装置管線図

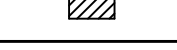

SYMBOLS FOR MAIN ENGINE PIPING DIAGRAM

主 機 関 諸 管 線 図 記 号

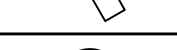
SYMBOLS 記 号	N A M E	名 称	R E M A R K S 備 考
	Nominal inner diameter	称 呼 口 径	
	Crossing pipes, connected	連 結 管	
	Crossing Pipes, not connected	不 連 結 管	
	To bilge	ビ ル ジ ヘ	
	Boss	ボ ス	
	Boss and plug	プ ラ グ 付 ボ ス	
	Joint, bossed	ボ ス 継 手	
	Joint, flanged	フ ラ ン ジ 継 手	
	Joint, screwed	ね じ 継 手	
	Tee joint, screwed	T 形 ね じ 継 手	
	Spectacle flange	め が ね フ ラ ン ジ	
	Blind flange	閉 止 フ ラ ン ジ	
	Orifice	オ リ フ ィ ス	
	Flexible pipe	フ レ キ シ ブ ル パ イ プ	
	Hopper	ホ ッ パ ー	
	Hopper with cover	ふ た 付 ホ ッ パ ー	
	Air pipe	空 気 抜 管	
	Loop seal pipe siphon	ル ー プ シ ール パ イ プ サ イ フ ォ ン	
	Siphon	サ イ フ ォ ン	

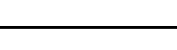
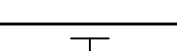
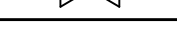
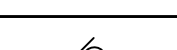
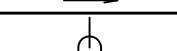
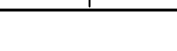
SYMBOLS 記号	NAME	名称	REMARKS 備考
-----	Elect. cable	電気配線	
-----	Outfit line (to be delivered by yard)	造船所掌配管	
	Pressure switch	圧力スイッチ	
	Temperature switch	温度スイッチ	
	Float switch	フロートスイッチ	
	Limit switch	リミットスイッチ	
	Oil mist detector	オイルミストディテクター	
	Pressure transmitter	圧力トランスミッター	
Bar Type 	Thermometer	温度計	
Dial Type 			
engine side 	Pressure gauge	圧力計	
on Gauge board 			
	U Tube manometer	U字管式圧力計	
	Cock	コック	
	Stop valve	止め弁	Globe valve 玉形弁
			Angle valve アングル弁
	Thermometer pocket	温度計座 (ポケット付)	
	Three-way cock	三方コック	(1) T形 (T-PORT) (2) L形 (L-PORT)
	Butterfly valve	バタフライ弁	
	Solenoid operated valve	電磁弁	
	Solenoid operated valve (angle)	電磁弁	

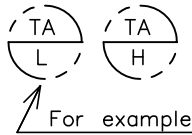
SYMBOLS 記号	NAME	名称	REMARKS 備考
	Gate valve	仕切弁	
	Hose valve	ホース弁	
	Hose valve (angle)	ホース弁 (アングル)	
	Safety valve	安全弁	
	Swing check valve	スイング逆止め弁	
	Swing check valve (angle)	スイング逆止め弁 (アングル)	
	Lift check valve	リフト逆止め弁	
	Diaphragm operated valve (with positioner & handle)	ダイヤフラム操作弁 (ポジションナ及びハンドル付)	
	Sight glass	サイトグラス	
	Simplex strainer	単式コシ	
	Duplex strainer	複式コシ	
	Y type strainer	Y形ストレーナ	
	Differential pressure gauge	差圧計	
	Reducer	レジューサ	
	Hose coupling	ホース継手	
	Regulating valve	自動調整弁	
	Ball valve	ボール弁	
	Check valve	逆止め弁	
	Seal pot	シールポット	

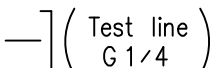
SYMBOLS 記号	NAME	名称	REMARKS 備考
	Remotely indicated (to be delivered by yard)	遠隔指示計	
PI	Pressure indication	圧力指示	
PSD	Pressure slow down	圧力減速	
PA	Pressure alarm	圧力警報	
TI	Temperature indication	温度指示	
TA	Temperature alarm	温度警報	
TSD	Temperature slow down	温度減速	
LI	Level indication	液面指示	
LA	Oil or water level alarm	液面警報	
FI	Flow indication	流れ指示	
FA	Flow alarm	流れ警報	
FSD	Flow slow down	流れ減速	
DPA	Differential pressure alarm	差圧警報	
H	High (high press.,high temp .,high level,high flow)	高圧, 高温, 高液面 高流量	
L	Low (low press.,low temp .,low level,low flow)	低圧, 低温, 低液面 低流量	
D	Deviation (Deviation temp)	温度偏差大	
	Fire alarm (Scavenging air trunk)	掃気室火災警報	
TR	Temperature sensor	温度センサー	
	For Test line	テスト用	
N.O.	Normal open	常時開	
N.C.	Normal close	常時閉	

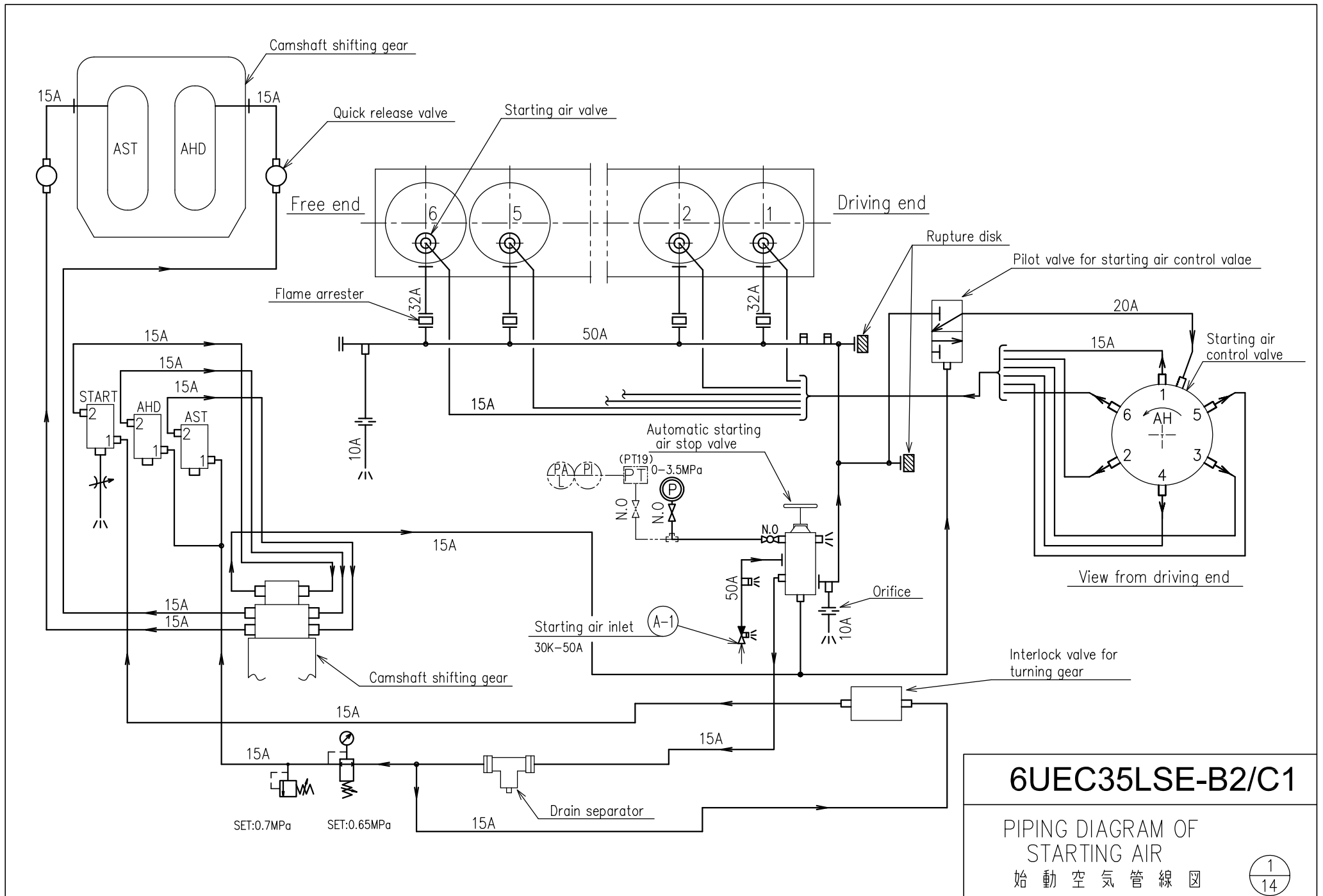

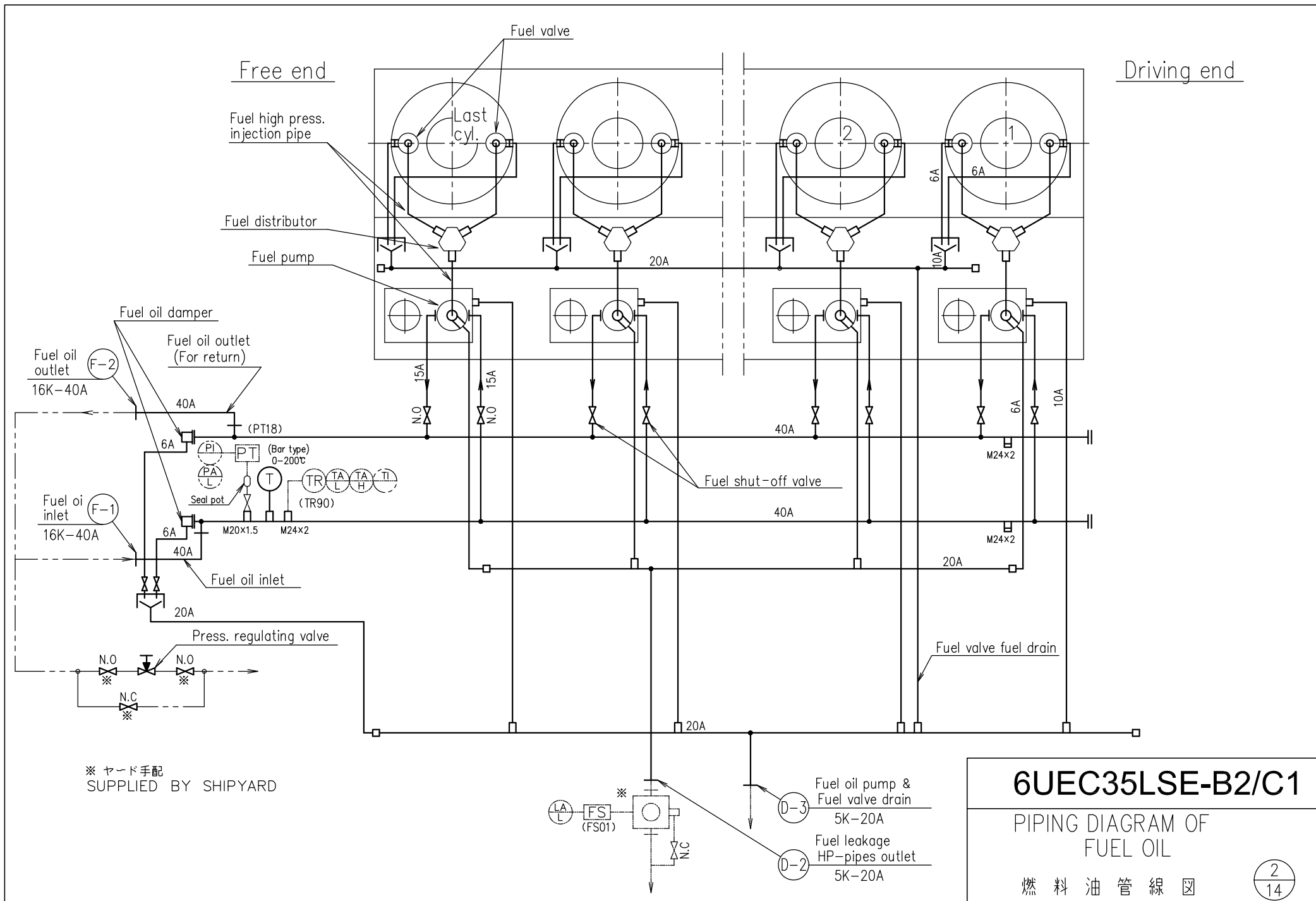

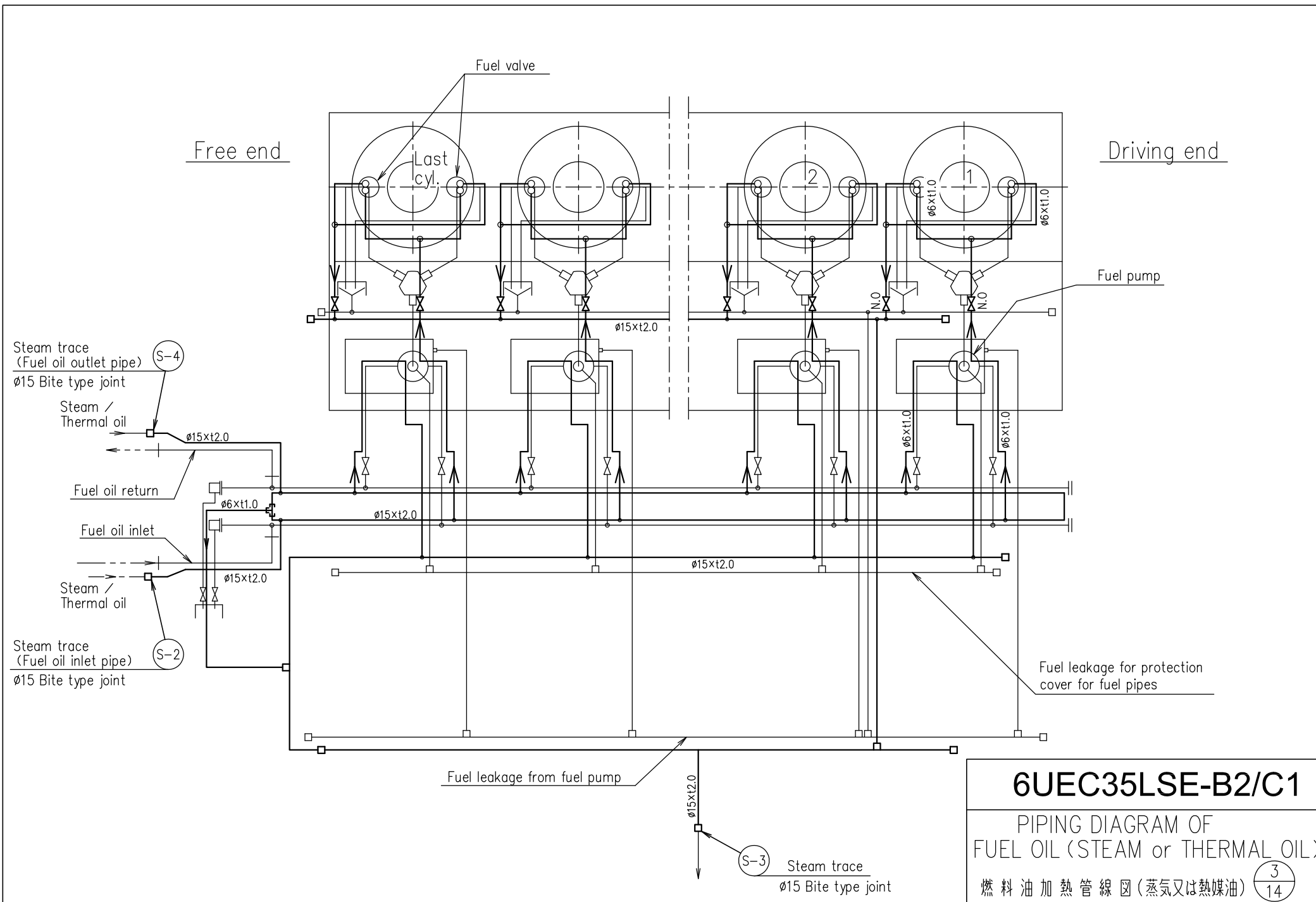

6UEC35LSE-B2/C1
 PIPING DIAGRAM OF
 FUEL OIL (STEAM or THERMAL OIL)
 燃料油加熱管線図 (蒸気又は熱媒油) 3 / 14

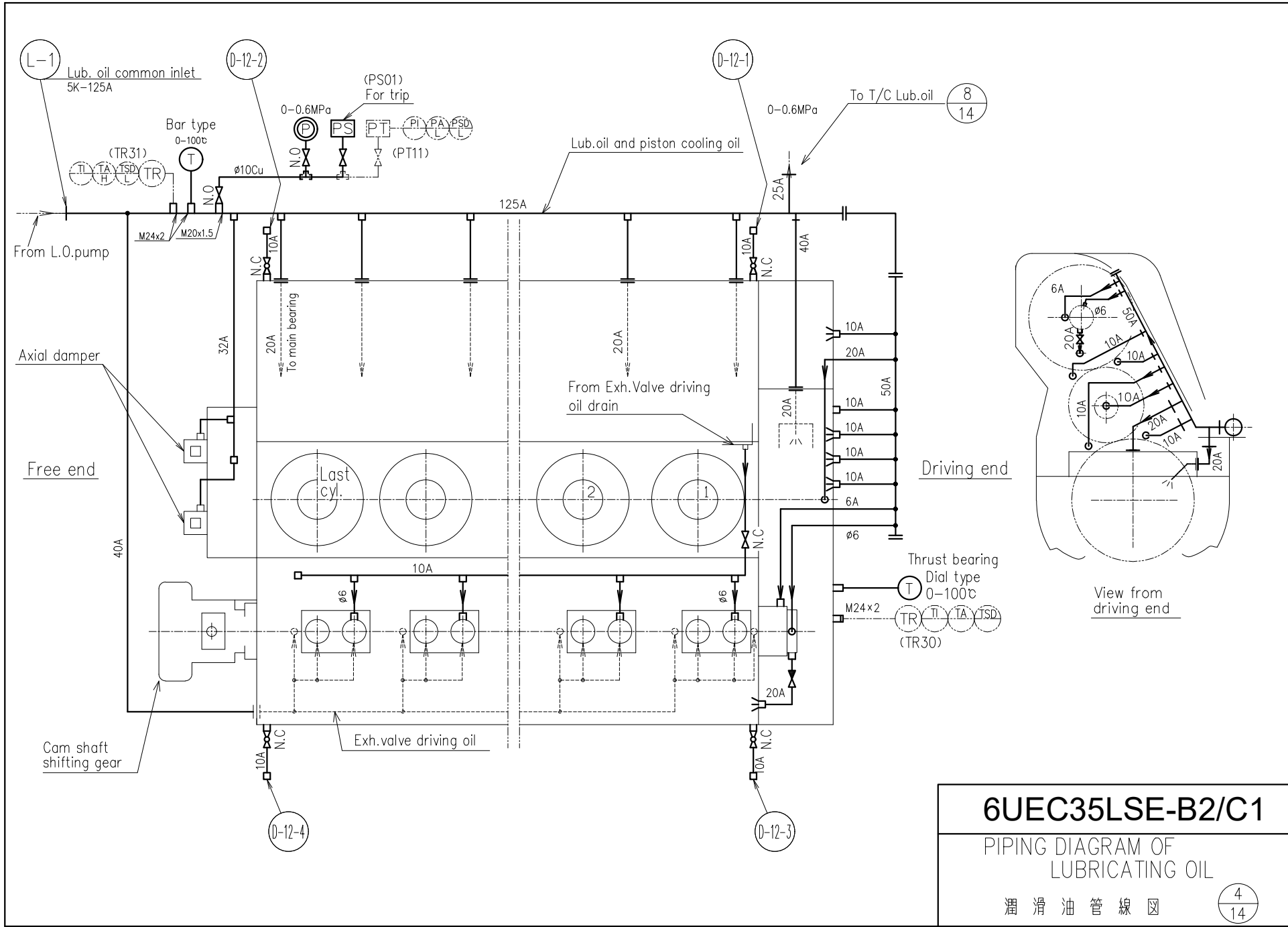

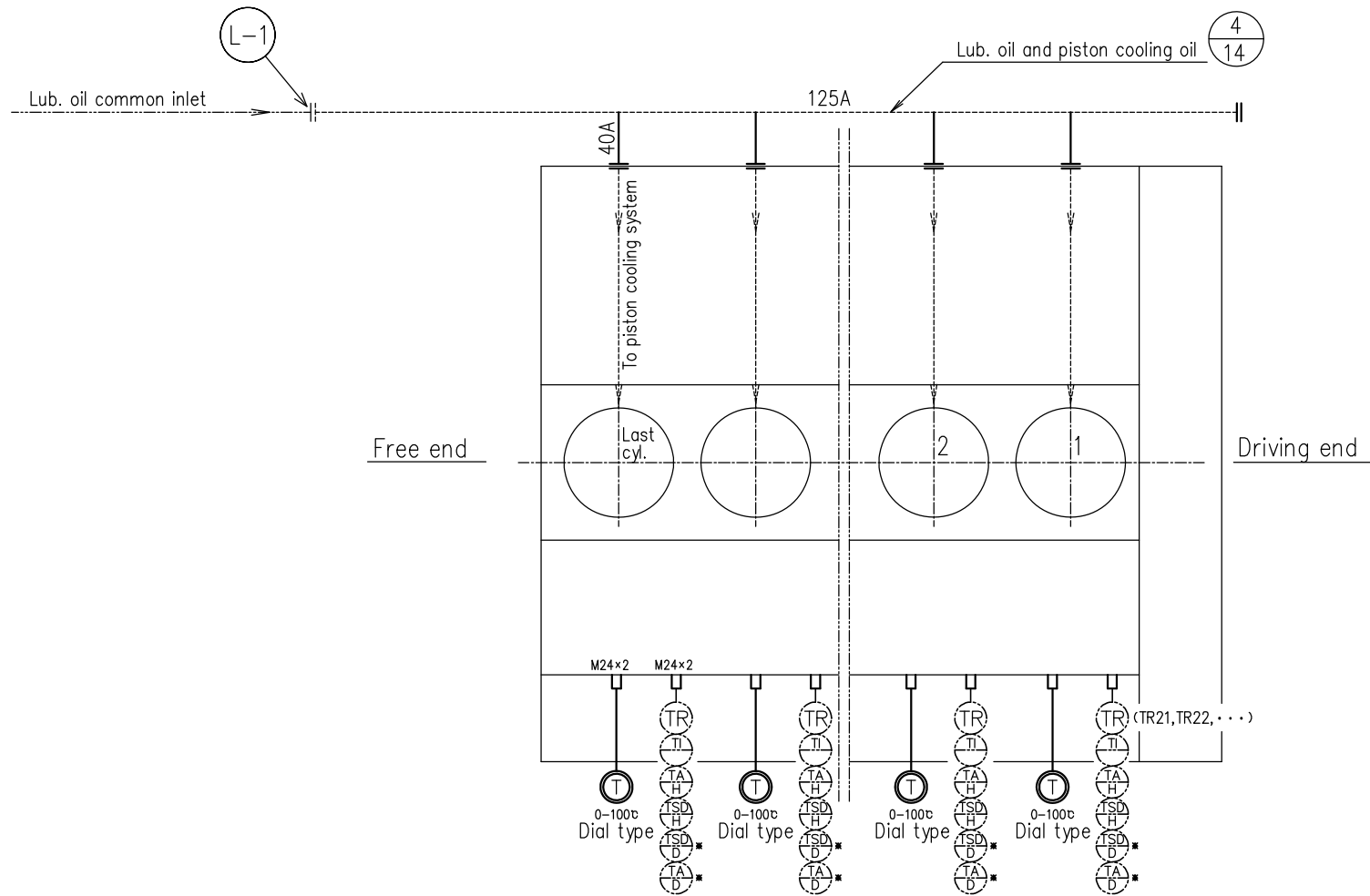

* As alternative to piston coolant flow sensor of each piston.

6UEC35LSE-B2/C1

PIPING DIAGRAM OF
PISTON COOLING OIL

ピストン冷却油管線図

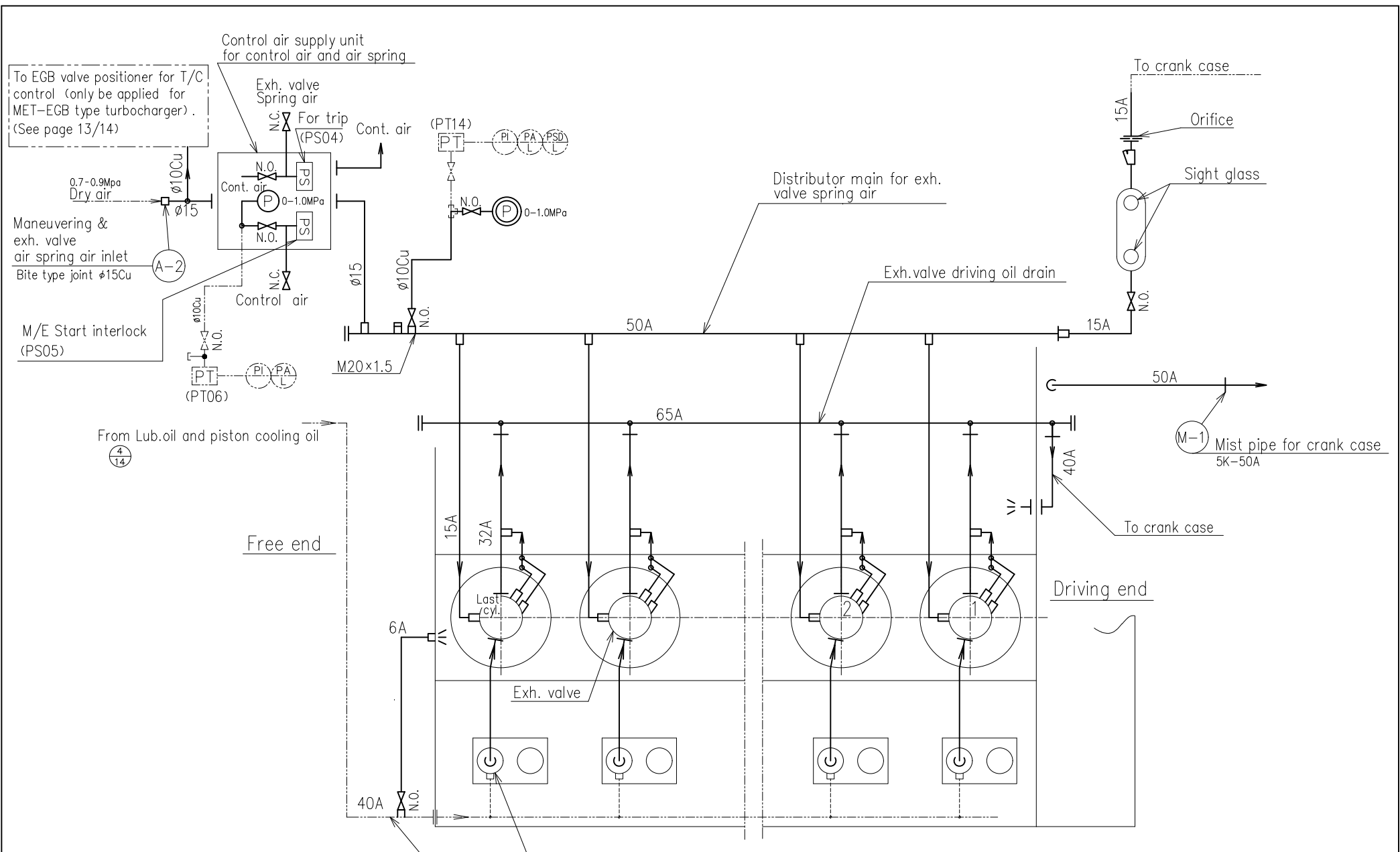

6UEC35LSE-B2/C1

PIPING DIAGRAM OF ACTUATOR OIL FOR EXH. VALVE

排气弁駆動油管線図

6/14

Cylinder lubricator inlet
5K-20A

L-3

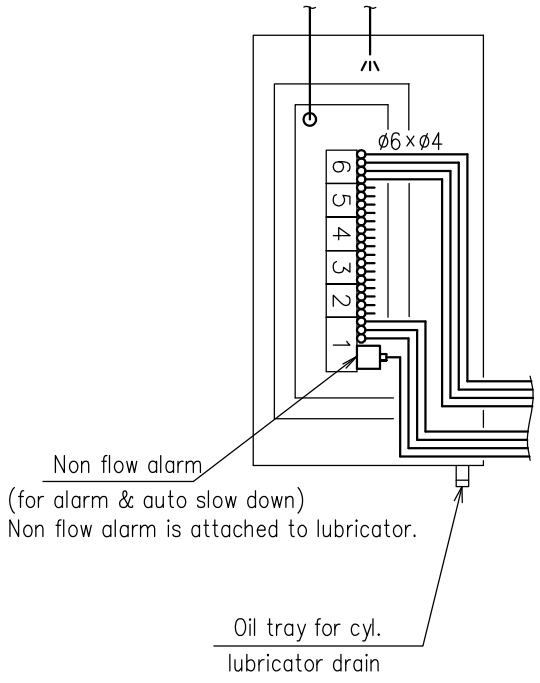
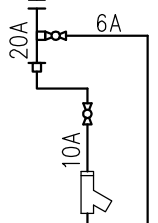

Non flow alarm with proximity switch

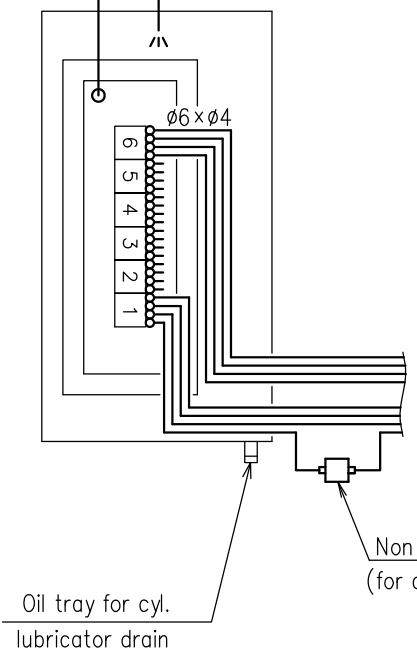

Non flow alarm with flow switch

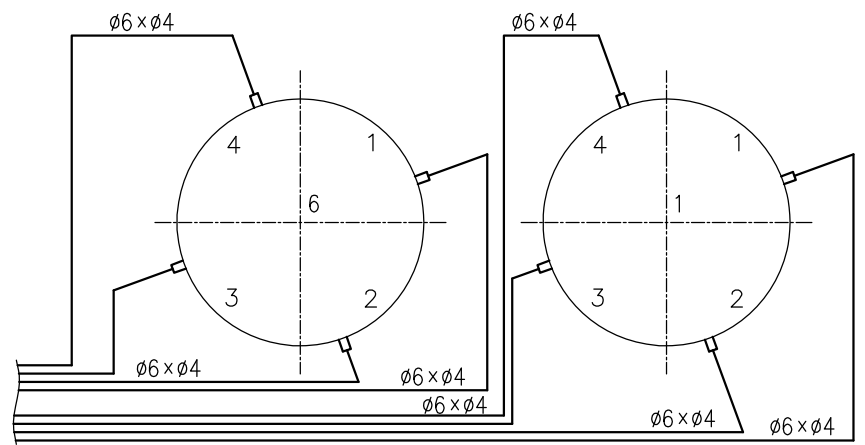

6UEC35LSE-B2/C1

PIPING DIAGRAM OF
CYLINDER LIBRICATING OIL

シリンダ注油管線図

7/14

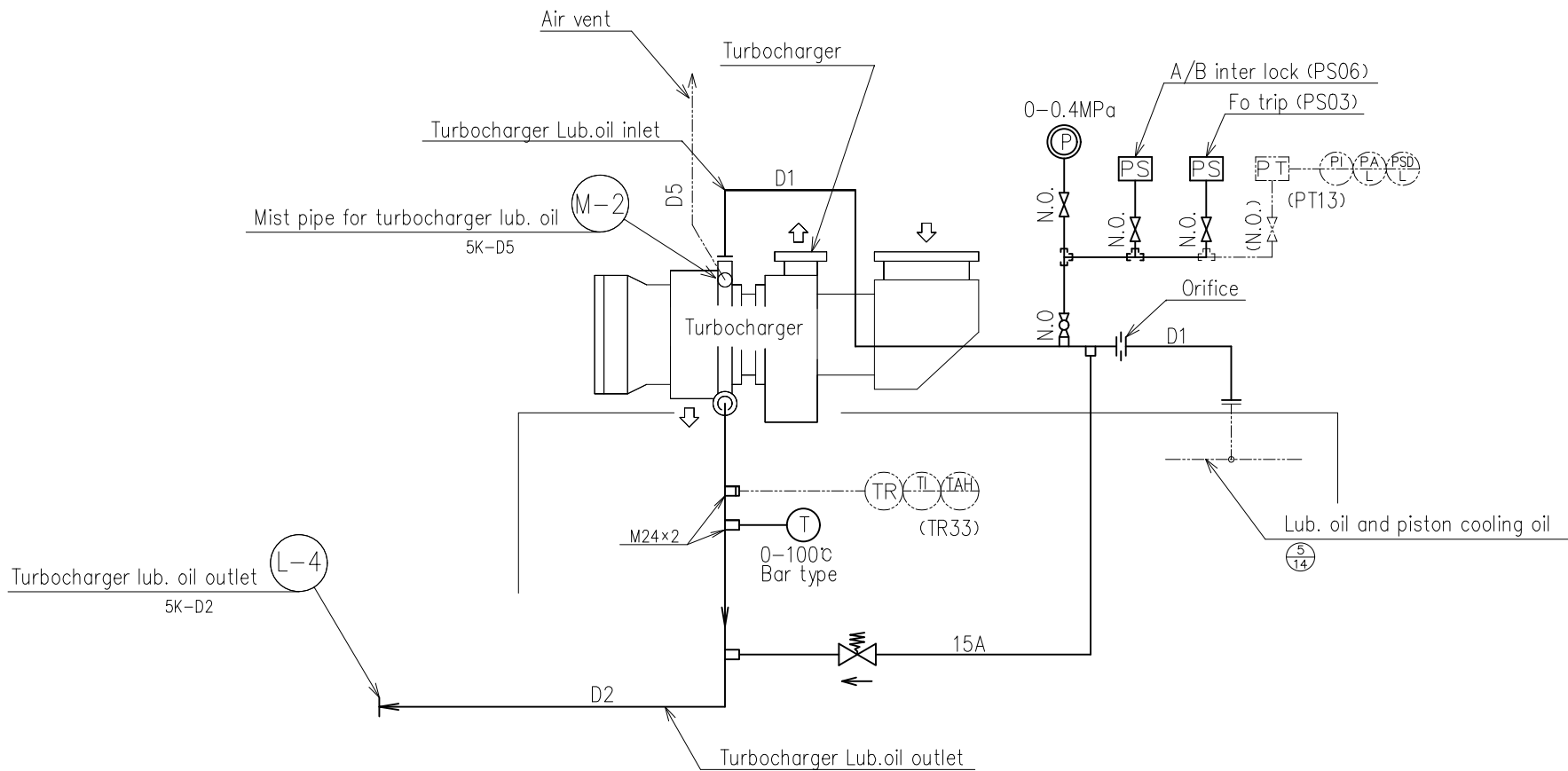

Turbocharger type	Pipe sizes		
	D1	D2	D5
MET42MB×1	25A	50A	50A
MET37MB×1	25A	50A	50A
MET33MB×1	20A	40A	32A

6UEC35LSE-B2/C1

PIPING DIAGRAM OF
TURBO CHARGER LUB. OIL

過給機潤滑油管線図

8
14
△

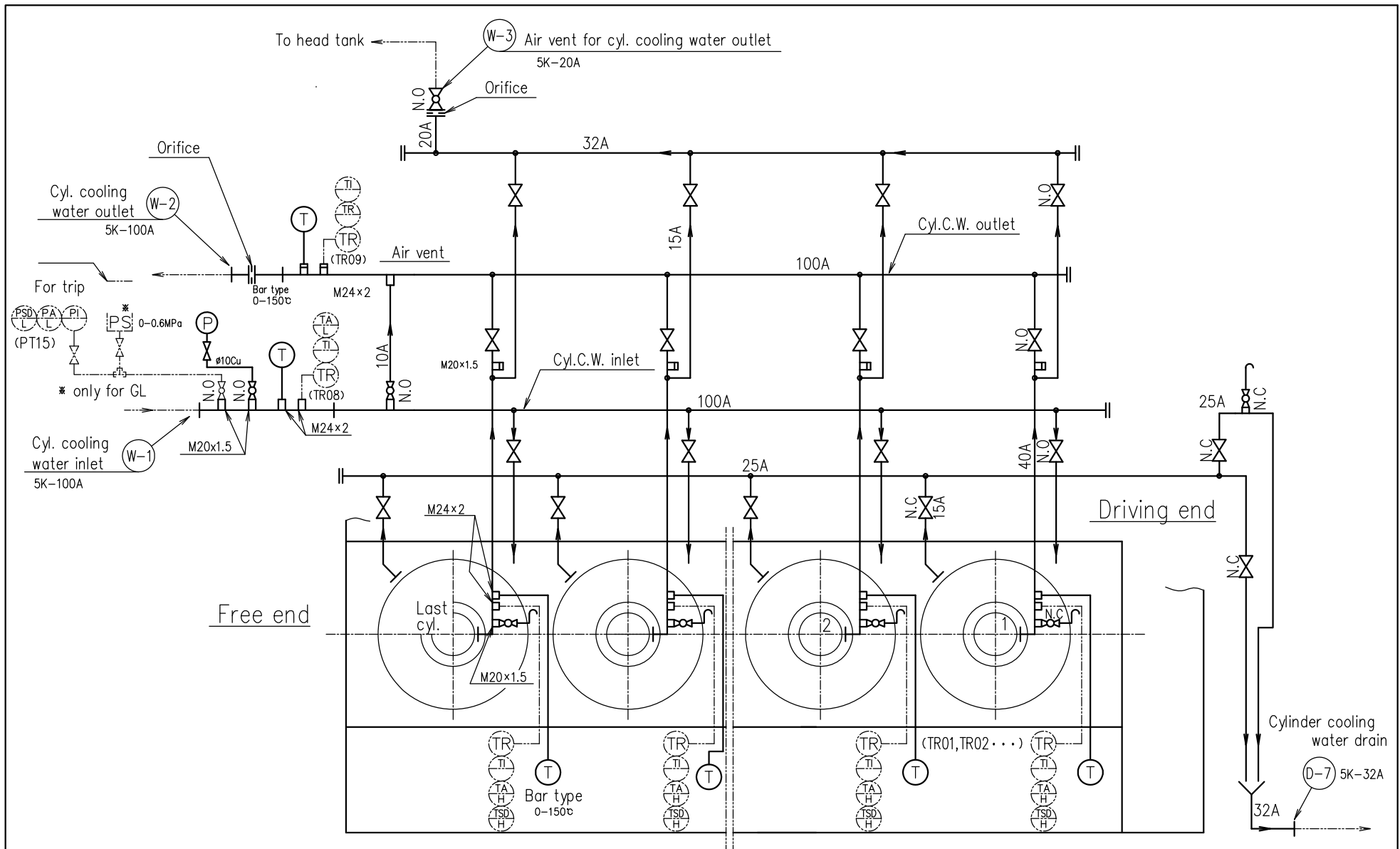

6UEC35LSE-B2/C1

PIPING DIAGRAM OF
CYLINDER COOLING WATER

シリンダ冷却水管線図

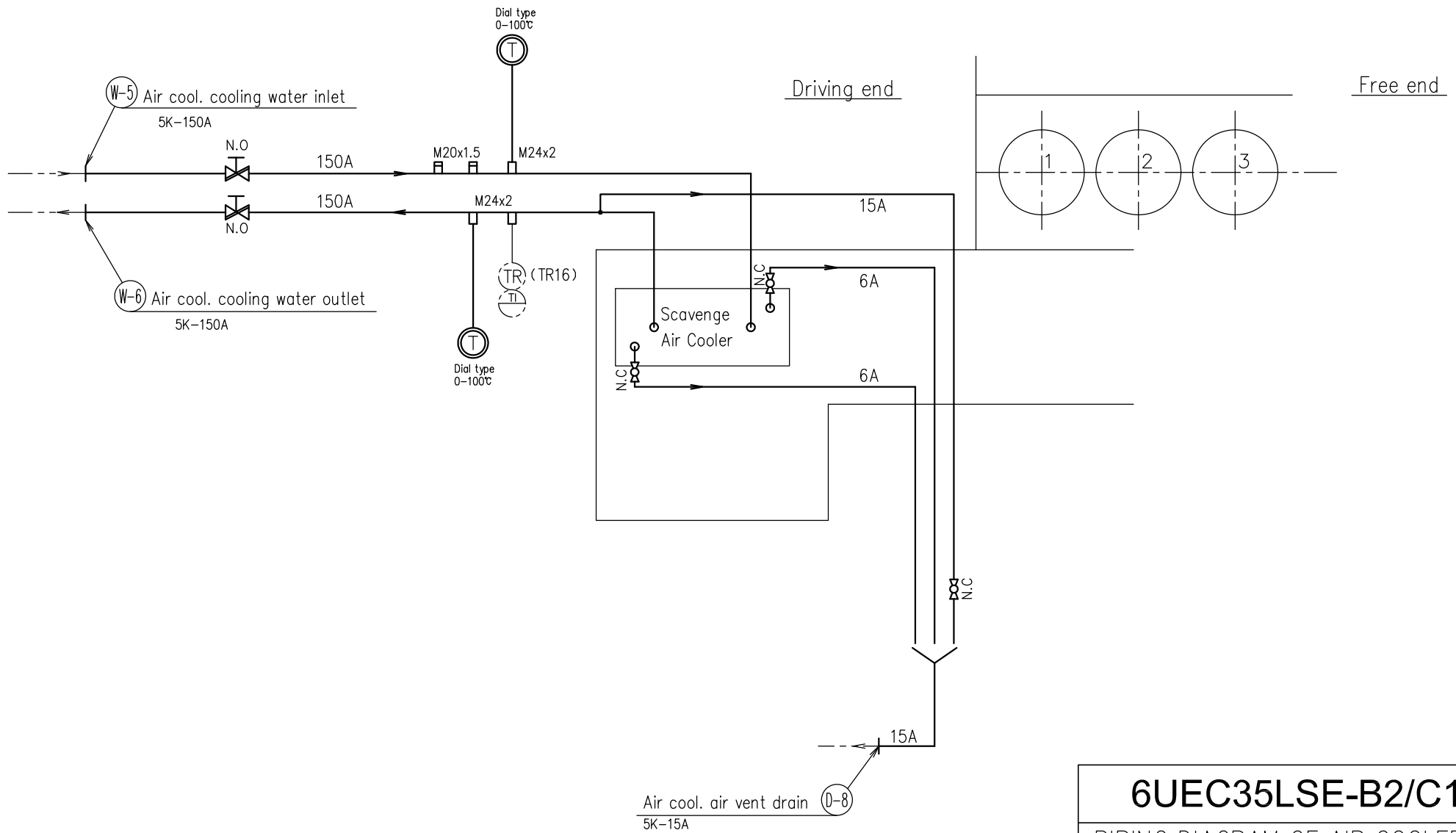

6UEC35LSE-B2/C1

PIPING DIAGRAM OF AIR COOLER
COOLING WATER

空気冷却器冷却水管線図 10
14

Free end

Driving end

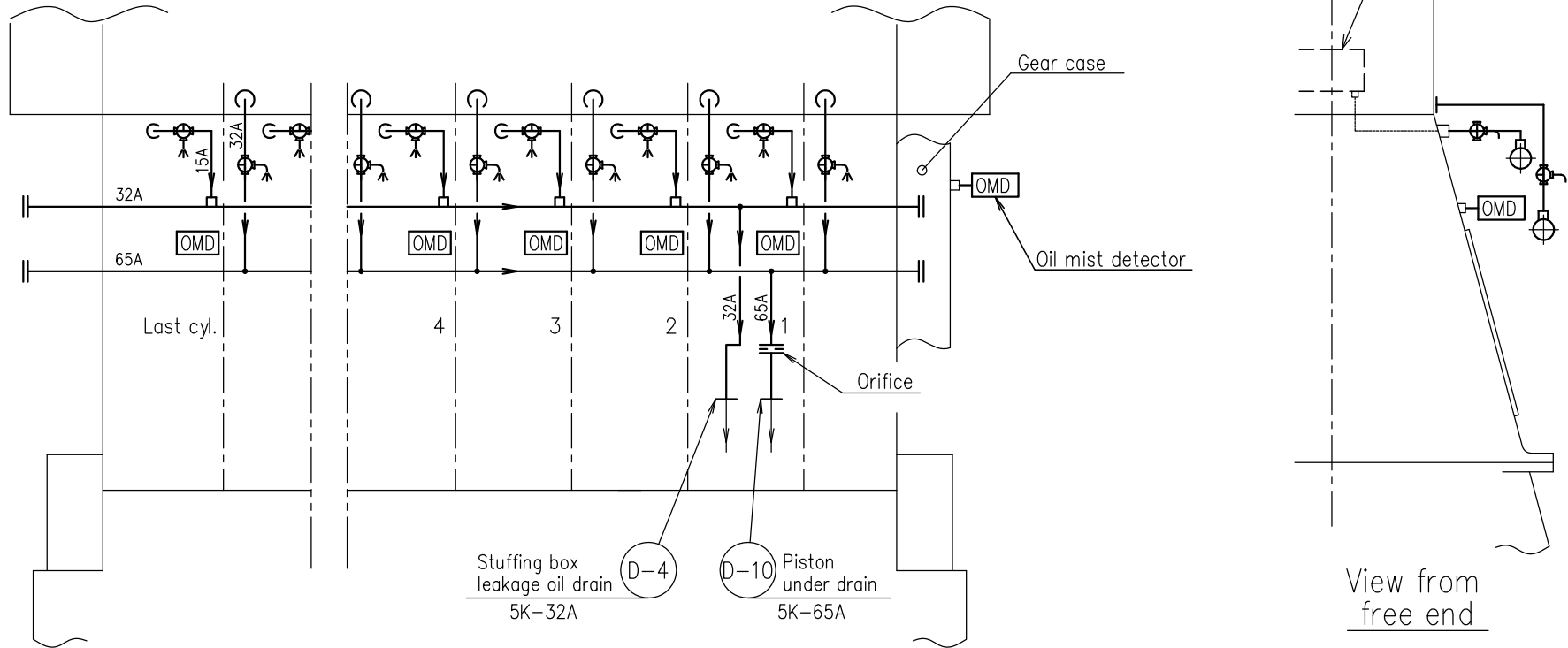

6UEC35LSE-B2/C1

PIPING DIAGRAM OF STUFFING BOX
LEAKAGE DRAIN AND PISTON UNDER DRAIN
ピストン棒パッキン箱ドレン管
及びシリンダ下部ドレン管線図

11
14

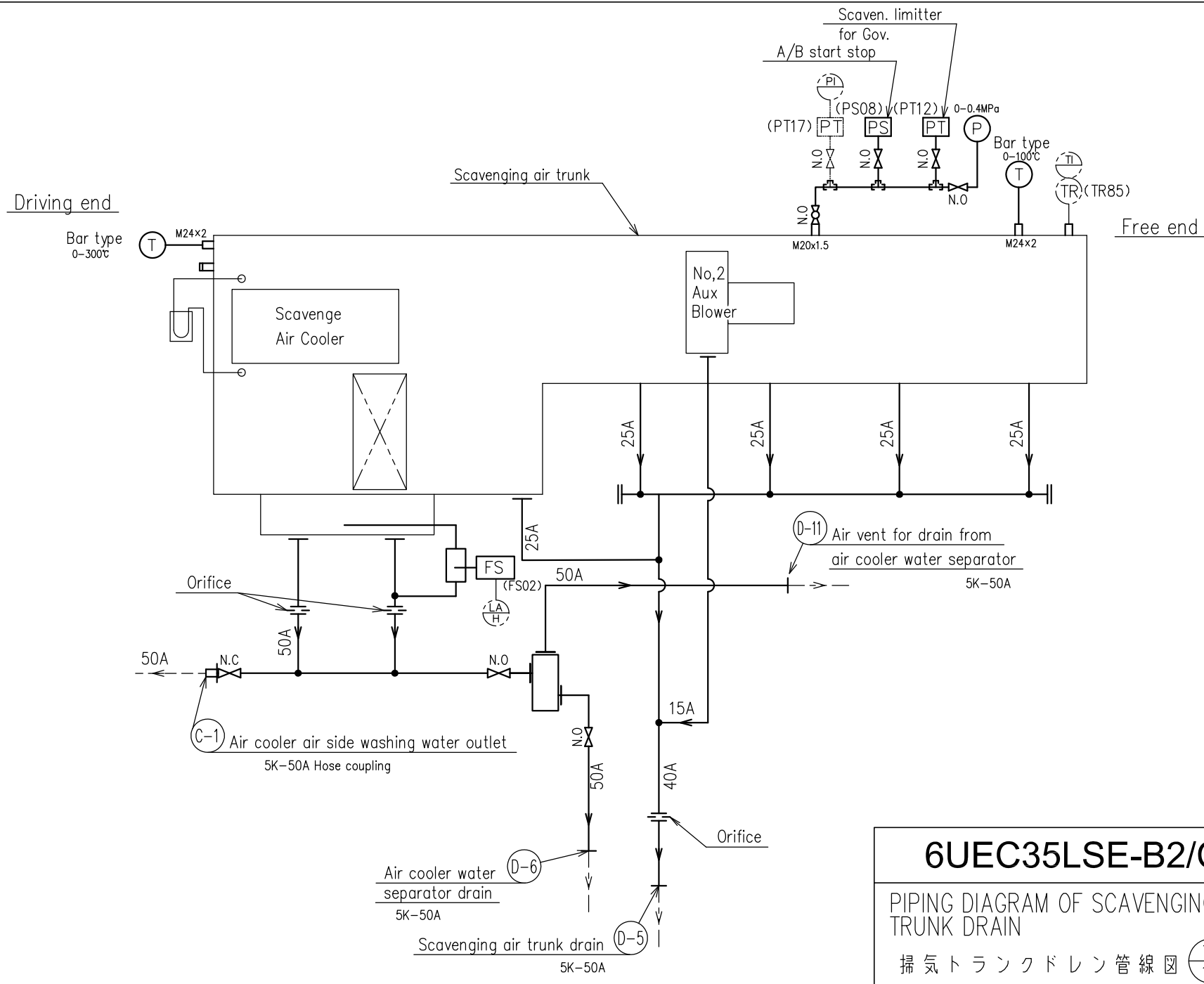

Driving end

Free end

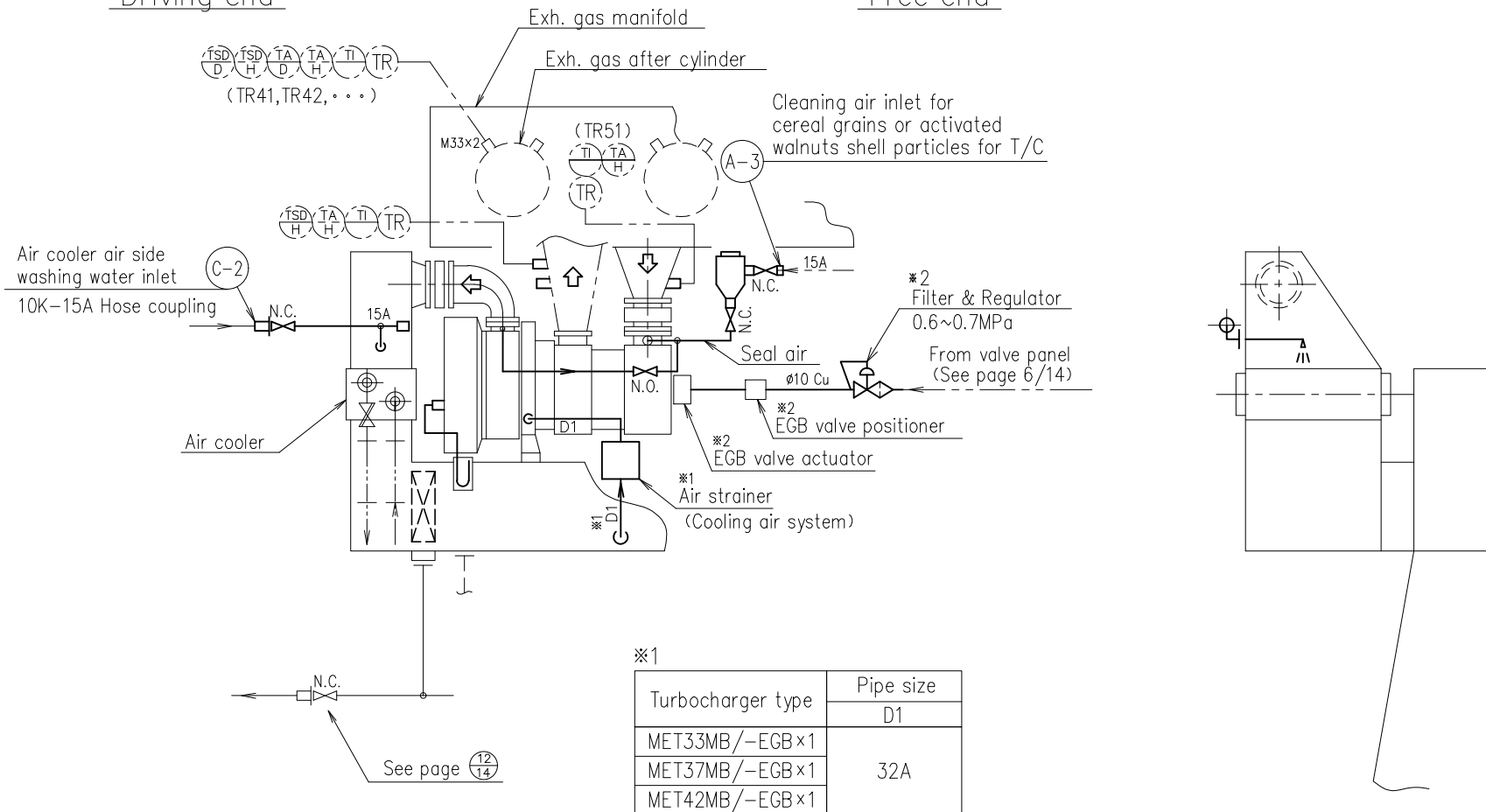

※1

Turbocharger type	Pipe size
MET33MB/-EGB×1	32A
MET37MB/-EGB×1	
MET42MB/-EGB×1	

※1 クーリングエアシステムは、機関の仕様により必要となる場合があります。お問い合わせください。

Depending on the engine specification, cooling air system may be required.

※2 MET-EGB 過給機のみ

Only for MET-EGB type turbocharger.

6UEC35LSE-B2/C1

PIPING DIAGRAM OF TURBO-CHARGER
AND AIR COOLER WASHING
WATER, AND EXHAUST GAS SYSTEM (13)
過給機空気冷却器洗浄水管及び排気ガス線図 (14)

Inlet for fire extinguishing appliance
for scavenging air trunk
10K-32A

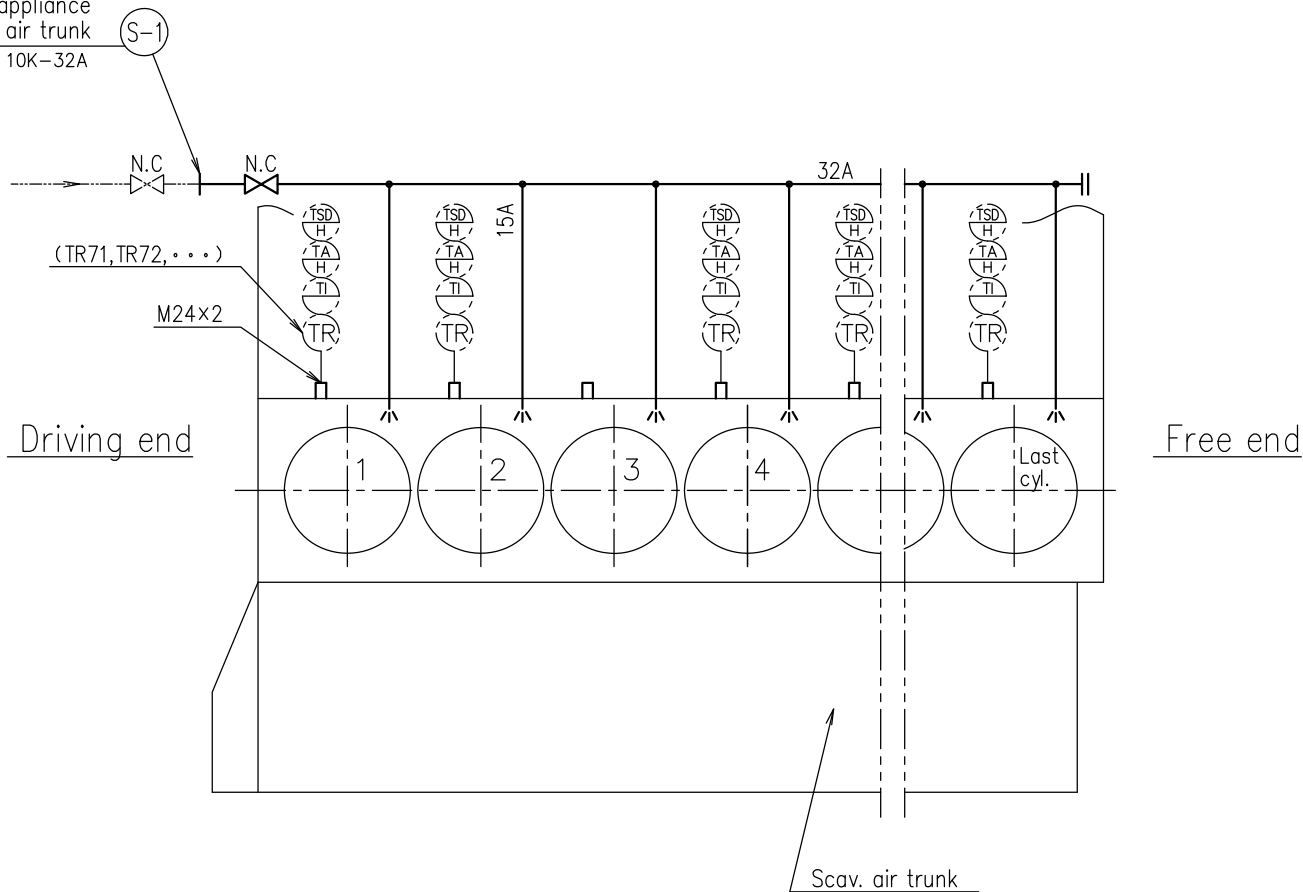

6UEC35LSE-B2/C1

PIPING DIAGRAM OF
FIRE EXTINGUISHING

掃氣室火災消火装置管線図